

Preliminary Data Sheet

Features

- For GSM applications
- Usable bandwidth 60 MHz
- High attenuation
- Superior amplitude and phase balance
- Single-ended input
- Balanced output
- Ceramic Surface Mount Package (SMP)
- Small size

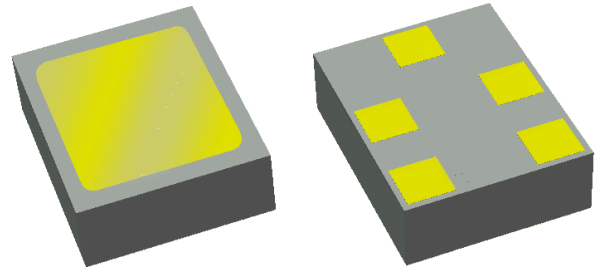

Package

Surface Mount 2.50 x 2.00 x 0.76 mm

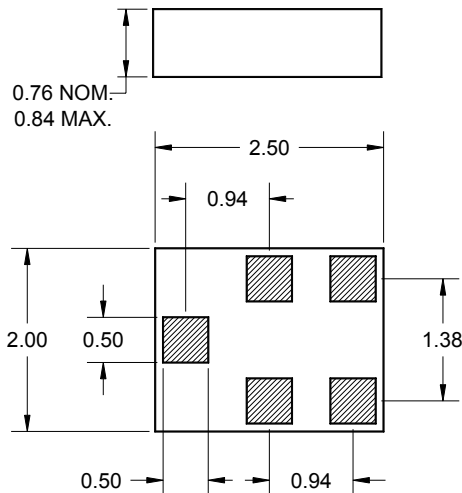

Dimensions shown are nominal in millimeters
All tolerances are ± 0.10 mm

Body: Al_2O_3 ceramic
Lid: Kovar or Alloy 42, Au over Ni plated
Terminations: Au plating 0.5 - 1.0 μ m,
over a 2 - 6 μ m Ni plating

Pin Configuration

Bottom View

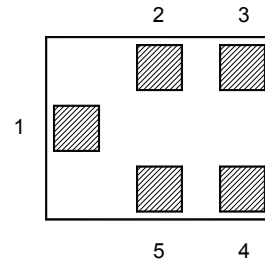

Pin No.	Description
1	Input, Unbalanced
2,5	Input, Case ground
3,4	Output, Balanced

Preliminary Data Sheet

Electrical Specifications ⁽¹⁾

Operating Temperature Range: ⁽²⁾ +25 °C

Parameter ⁽³⁾	Minimum	Typical	Maximum	Unit
Center Frequency	-	1960	-	MHz
Maximum Insertion Loss 1930 - 1990 MHz	-	2.6	3.0	dB
Absolute Attenuation				
0 - 1000 MHz	45	55	-	dB
1000 - 1830 MHz	28	31	-	dB
1830 - 1910 MHz	14	17	-	dB
2010 - 2070 MHz	13	15	-	dB
2070 - 3000 MHz	22	24	-	dB
3000 - 5000 MHz	35	37	-	dB
5000 - 6000 MHz	30	34	-	dB
Input/Output Return Loss 1930 - 1990 MHz	8.5	10.5	-	dB
Output Amplitude Balance (S₃₁/S₂₁) 1930 - 1990 MHz	-1.5	0.7	1.5	dB
Output Phase Balance $\phi(S_{31}) - \phi(S_{21})$ 1930 - 1990 MHz	168	178 -187	192	degree
Source Impedance	-	50	-	Ω
Optimal Load Impedance ⁽⁴⁾	-	200 16nH	-	Ω

Notes:

1. All specifications are based on the test circuit shown below
2. This specification is valid for room temperature only. The specification over the full temperature range(s) is available on the next page(s)
3. Electrical margin has been built into the design to account for the variations due to manufacturing tolerances
4. This is the optimum impedance for maximum power transfer given a 50 ohm source impedance

Test Circuit:

Actual matching values may vary due to PCB layout and parasitics

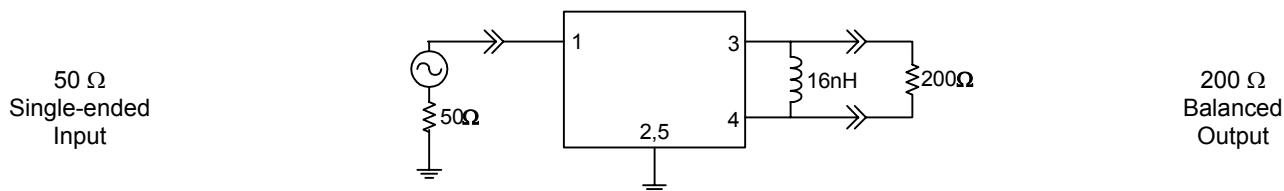

Preliminary Data Sheet

Electrical Specifications ⁽¹⁾

Operating Temperature Range: ⁽²⁾ -25 to +80 °C

Parameter ⁽³⁾	Minimum	Typical	Maximum	Unit
Center Frequency	-	1960	-	MHz
Maximum Insertion Loss				
1930 - 1990 MHz	-	2.6	4.0	dB
1930 - 1990 MHz (-10 to +75 °C)	-	2.6	3.5	dB
Absolute Attenuation				
0 - 1000 MHz	45	55	-	dB
1000 - 1830 MHz	25	31	-	dB
1830 - 1910 MHz	10	17	-	dB
2010 - 2070 MHz	7	15	-	dB
2070 - 3000 MHz	20	24	-	dB
3000 - 5000 MHz	33	37	-	dB
5000 - 6000 MHz	30	34	-	dB
Input/Output Return Loss				
1930 - 1990 MHz	8.5	10.5	-	dB
Output Amplitude Balance (S₃₁/S₂₁)				
1930 - 1990 MHz	-1.5	0.7	1.5	dB
Output Phase Balance $\phi(S_{31}) - \phi(S_{21})$				
1930 - 1990 MHz	168	178 -187	192	degree
Source Impedance	-	50	-	Ω
Optimal Load Impedance ⁽⁴⁾	-	200 16nH	-	Ω

Notes:

1. All specifications are based on the test circuit shown below
2. In production, devices will be tested at room temperature to a guardbanded specification to ensure electrical compliance over temperature
3. Electrical margin has been built into the design to account for the variations due to temperature drift and manufacturing tolerances
4. This is the optimum impedance for maximum power transfer given a 50 ohm source impedance

Test Circuit:

Actual matching values may vary due to PCB layout and parasitics

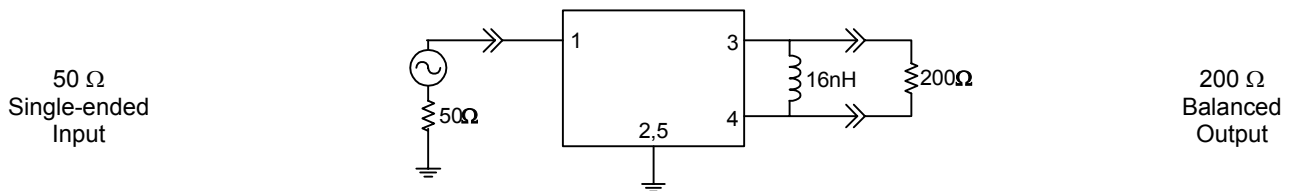

Preliminary Data Sheet

Typical Performance (at +25°C)

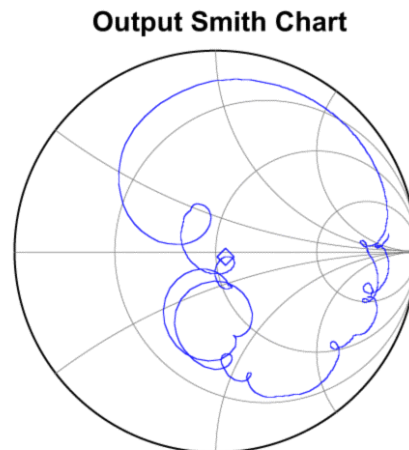
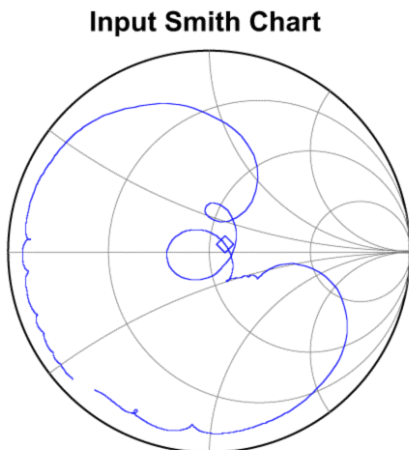
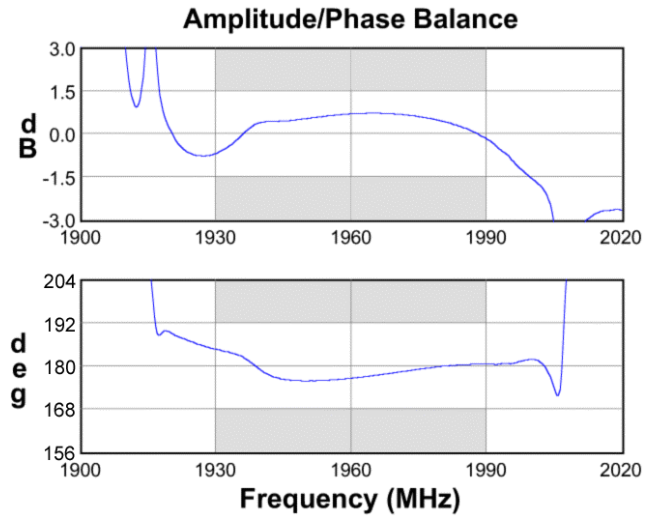
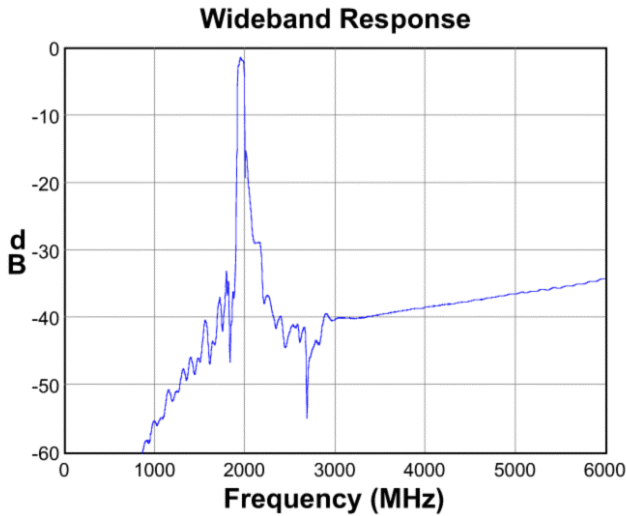
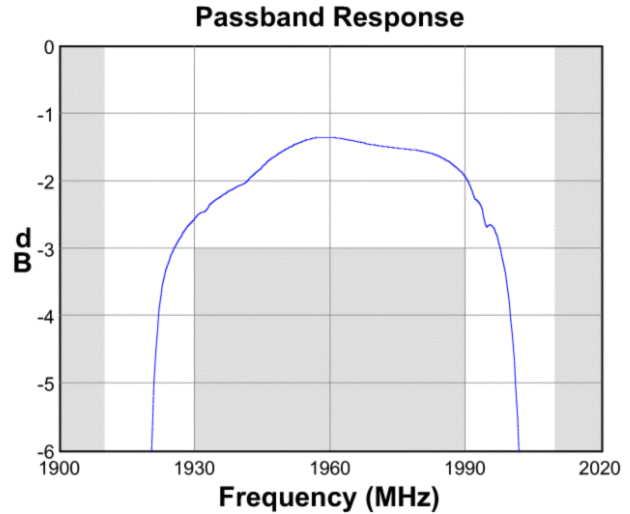
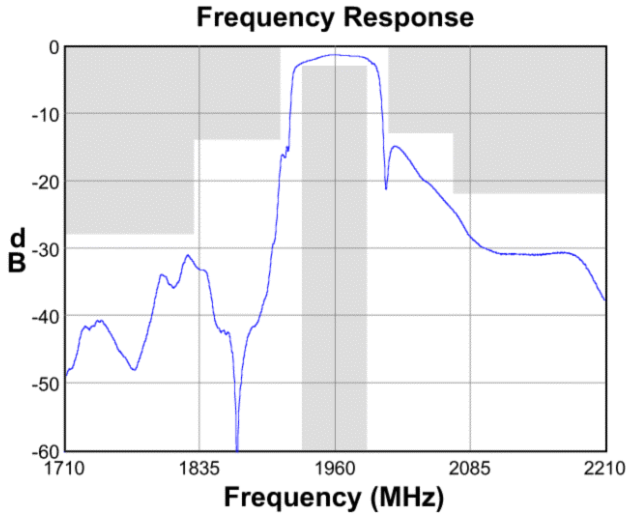

Preliminary Data Sheet

Matching Schematics

Actual matching values may vary due to PCB layout and parasitics

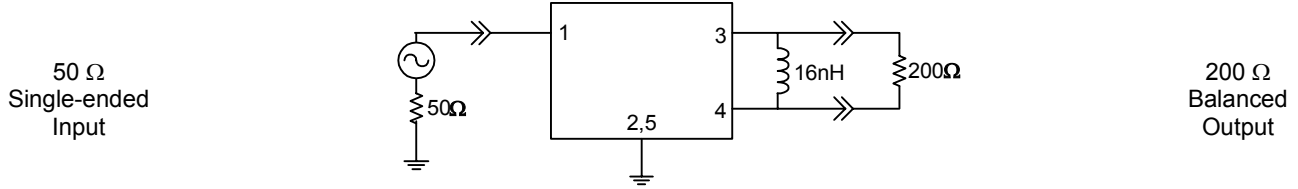

Marking

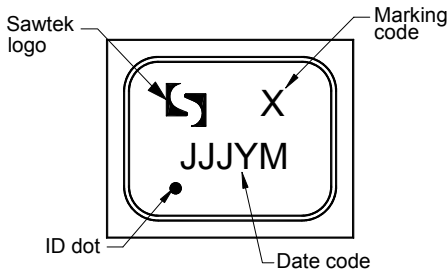

The date code consists of: JJJ = Julian day, Y = last digit of year, M = manufacturing site code

PCB Footprint

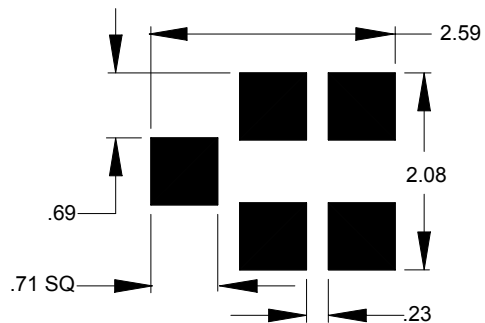

This footprint represents a recommendation only
Dimensions shown are nominal in millimeters

Tape and Reel

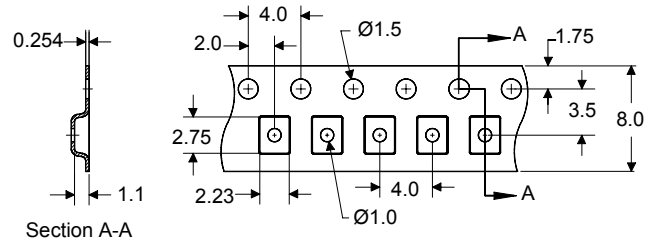
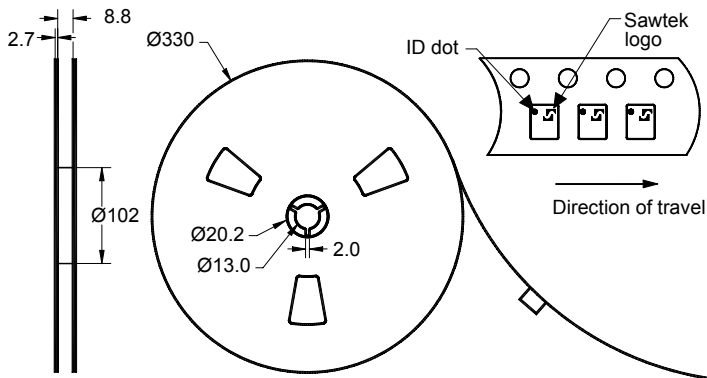

Dimensions shown are nominal in millimeters
Packaging quantity: 10000 units/reel

Preliminary Data Sheet

Maximum Ratings

Parameter	Symbol	Minimum	Maximum	Unit
Operating Temperature Range	T	-25	+80	°C
Storage Temperature Range	T _{stg}	-40	+85	°C

Warnings

- Electrostatic Sensitive Device (ESD) 
- Avoid ultrasonic exposure

Links to Additional Technical Information

[PCB Layout Tips](#)

[Qualification Flowchart](#)

[Soldering Profile](#)

[S-Parameters](#)

[Other Technical Information](#)

Sawtek's liability is limited only to the Surface Acoustic Wave (SAW) component(s) described in this data sheet. Sawtek does not accept any liability for applications, processes, circuits or assemblies which are implemented using any Sawtek component described in this data sheet.

Contact Information



PO Box 609501
 Orlando, FL 32860-9501
 USA

Phone: +1 (407) 886-8860
 Fax: +1 (407) 886-7061
 Email: custservice@sawtek.com
 Web: www.sawtek.com

Or contact one of our worldwide
 Network of [sales offices](#),
[Representatives or distributors](#)